

**Series 6, Washing machine, front loader, 9 kg, 1400 rpm
WGG24400GB**



Perfect results with minimum energy and water consumption, thanks to energy Class A and ActiveWater Plus.

- **Best energy class A:** save energy with the most efficient class A.
- **Speed Perfect:** get the perfect clean in up to 65% less time.
- **AntiStain:** reliably removes four of the most common stains.
- **Iron Assist:** reduce wrinkles up to 50%
- **ActiveWater Plus:** For highly efficient use of water even with smaller loads thanks to automatic load detection.

Energy Efficiency Class: A
 Weighted energy consumption in kWh per 100 washing cycles of eco 40-60 programme: 49 kWh
 Maximum capacity in kg: 9.0 kg
 The water consumption of the eco programme in liters per cycle: 50 l
 Duration of eco 40-60 programme in hours and mins at rated capacity: 3:48 h
 Spin-drying efficiency class of eco 40-60 programme: B
 Airborne acoustical noise emission class: A
 Airborne acoustical noise emissions : 71 dB(A) re 1pW
 Built-in / Free-standing: Freestanding
 Dimensions of the product: 845x598x588 mm
 Net weight: 71.0 kg
 Connection rating: 2300 W
 Fuse protection: 10 A
 Voltage: 220-240 V
 Frequency: 50 Hz
 Length electrical supply cord: 210.0 cm
 Door hinge: Left
 Wheels: No
 EAN code: 4242005444571
 Installation typology: Free-standing

- WMZ2200 Floor securing component
 WMZ2381 Extension for cold water inlet /Aquastop
 WMZPW20W Platform with pull-out, washer, cubic



Series 6, Washing machine, front loader, 9 kg, 1400 rpm WGG24400GB

Perfect results with minimum energy and water consumption, thanks to energy Class A and ActiveWater Plus.

Performance

- Energy Efficiency Class¹: A
- Energy² / Water³: 49 kWh / 50 litres
- Load capacity: 1 - 9 kg
- Programme duration⁴: 3:48 h:min
- Spin drying efficiency class: B
- Spin speed^{**}: 400 - 1400 rpm
- Noise level: 71 dB (A) re 1 pW
- Noise efficiency class: A

Programmes/functions

- Standard programmes: cottons, easy care, delicates, wool hand wash
- Iron Assist: Steam programme that reduces wrinkles on dry clothes
- Special programmes: Drum clean with reminder, Jeans, Drain / Spin, Mixed Load, Sportswear, Single Rinse, Super Quick 15/30, Hygiene

Key features

- SpeedPerfect: perfectly clean in up to 65% less time. ***
- AntiStain - 4 stain removal options at the touch of a button
- Touch control buttons: Reduced Ironing option, Ready in, stain selection, Rinse Plus, start/pause with reload function, Temperature selection, SpeedPerfect, Prewash, Spin speed reduction/Rinse Hold

Additional features

- Reload function: Flexibility to add or remove laundry items of any size even after start of the wash cycle.
- Large LED-Display for programme status indication, max. spin speed, remaining time and 24 h end time delay and load recommendation
- Hygiene Plus: clean laundry and effective removal of germs
- Drum volume: 65 litres
- Usage meter: counts completed programmes
- Drum interior light
- VarioDrum: gentle and efficient washing
- Drum clean with reminder function
- Large black-blackgrey door with 160° opening
- Reload function: Flexibility in adding laundry items into the drum, even after the wash cycle has started.
- EcoSilence drive with 10 year warranty
- EcoSilence drive with 10 year warranty
- ActiveWater Plus: for highly efficient use of water even with smaller loads thanks to automatic load detection.
- AntiStain
- AntiVibration Design - for more stability and quietness
- Aqua Protection
- soft dial
- Foam detection system

- Safeguard monitoring system adjusts load distribution and programme settings to protect clothes
- Child lock
- Acoustic signals: Buzzer
- Detergent dispensing: easy clean
- Divider for Liquid Detergent

Technical Information

- Slide-under installation
- Dimensions (H x W): 84.5 cm x 59.8 cm
- Appliance depth: 58.8 cm
- Appliance depth incl. door: 63.2 cm
- Appliance depth with open door: 104.9 cm

¹ Scale of Energy Efficiency Classes from A to G

² Energy consumption in kWh per 100 cycles (in programme Eco 40-60)

³ Weighted water consumption in litres per cycle (in programme Eco 40-60)

⁴ Duration of Eco 40-60 programme

** Values are rounded.

*** Comparison between the program duration of Easy-care 40°C and the program duration of Easy-care 40°C + activated Speed option

**Series 6, Washing machine, front loader, 9 kg, 1400 rpm
WGG24400GB**

Measurements in mm

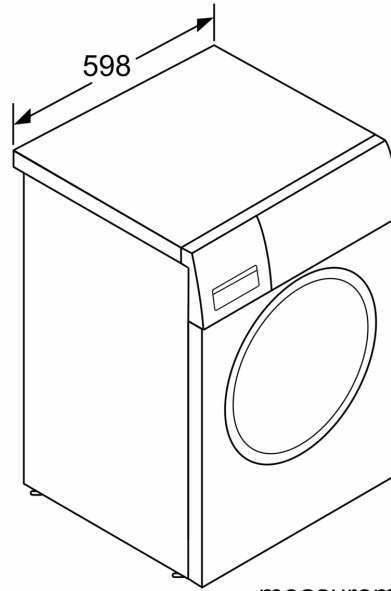
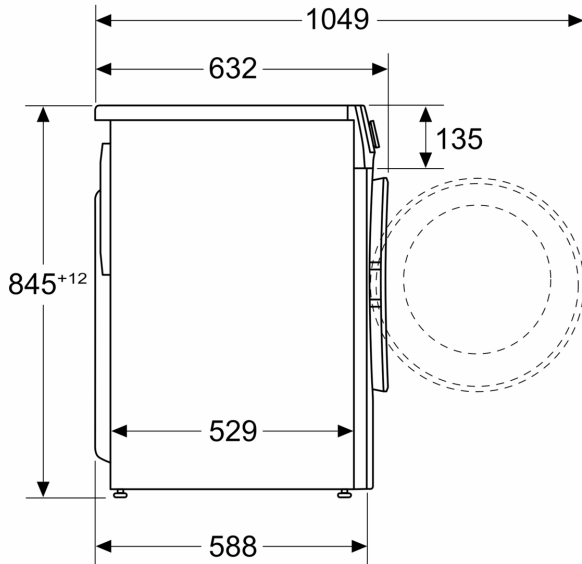

measurements in mm