

# FAB32LBL5UK



<b>Product Family</b>	Refrigerator
<b>Installation</b>	Free Standing
<b>Category</b>	Bottom Mount
<b>Reference width</b>	Until 60
<b>No-Frost system</b>	Total
<b>Cooling type</b>	Total No Frost - Double Cooling system
<b>Defrost</b>	Automatic
<b>Hinge type</b>	Standard
<b>Hinge position</b>	Left
<b>EAN code</b>	8017709298258



## Aesthetics



<b>Aesthetics</b>	50's Style	<b>Side material</b>	Steel
<b>Colour</b>	Black	<b>Side colour</b>	Black
<b>Finishing</b>	Gloss	<b>Logo</b>	Applied
<b>Design</b>	Rounded	<b>Door shelves profile colour</b>	Chrome
<b>Material</b>	Heat-moulded	<b>Drawers profile colour</b>	Chrome
<b>Handle</b>	External	<b>Colour of glass shelf profile</b>	Chrome
<b>Handle type</b>	Fixed	<b>Display</b>	LED
<b>Handle colour</b>	Chrome	<b>Display position</b>	Interior (on the top)
<b>Logo colour</b>	Chrome	<b>Colori disponibili</b>	Orange, Pastel blue, White, Blue, Black, Cream, Pink, Red, Silver, Pastel green, Lime green

## Refrigerator compartment features



<b>No. of adjustable shelves</b>	2	<b>Type of crisper/vegetable drawers cover</b>	Glass
<b>Number of fruit and vegetables drawers</b>	1	<b>Life Plus zone-0°C</b>	0°C
<b>Type of adjustable shelves</b>	Glass	<b>Internal light in fridge</b>	Yes
		<b>Type of internal light (fridge)</b>	LED

Type of crisper/vegetable drawers cover Standard

Crisper Cover Yes

## Refrigerator Inner Door

No. of door shelves with transparent cover 1

Number of adjustable door shelves 2

Adjustable door shelves with wire support Yes

No. of bottle shelves 1

Bottle shelves with wire support Yes

## Other Refrigerator features



MultiFlow Yes

Fan Yes

## Freezer compartment features

Number of drawers 3

No. of compartments with flap 1

Type of shelves Glass

## Other Freezer features



Fast freezing compartment Yes

## Other technical features



Functions display

Holiday, Fast freezing, Fast cooling, ECO, Temperature alarm

Fast freezing button

Yes

Power on lamp

Yes

Temperature alarm lamp

Yes

Door open alarm

Acoustic and visual

Temperature Alarm

Yes

Type of temperature control

Electronic

No. of compressors

1

Refrigerant gas type

R600a

Type of compressor

Variable Speed Compressor

Refrigerant Quantity (gr)

60 g

## Performance / Energy Label NEW

<b>Annual energy consumption</b>	204 KWh/year	<b>Noise level</b>	37 dB(A) re 1 pW
<b>Energy efficiency class</b>	D	<b>Thaw time</b>	40 h
<b>Airborne acoustical noise emission class</b>	C	<b>4 star - Freezing capacity</b>	6 Kg/24h
<b>Total volume</b>	331 l	<b>Climatic class</b>	SN, N, ST, T
<b>Sum of the volumes of the frozen compartment(s)</b>	97 l	<b>EI</b>	80 %
<b>Sum of the volumes of the chill compartment(s) and the unfrozen compartment(s)</b>	234 l		

## Electrical Connection

<b>Plug</b>	(G) UK e Singapore	<b>Voltage (V)</b>	220-240 V
<b>Nominal power</b>	127 W	<b>Frequency (Hz)</b>	50/60 Hz
<b>Current</b>	0,8 A	<b>Power supply cable length</b>	180 cm

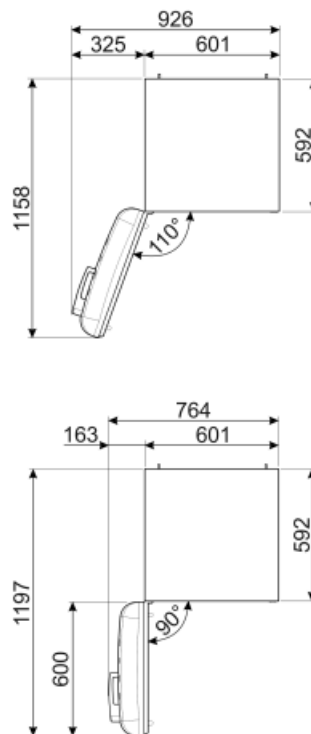
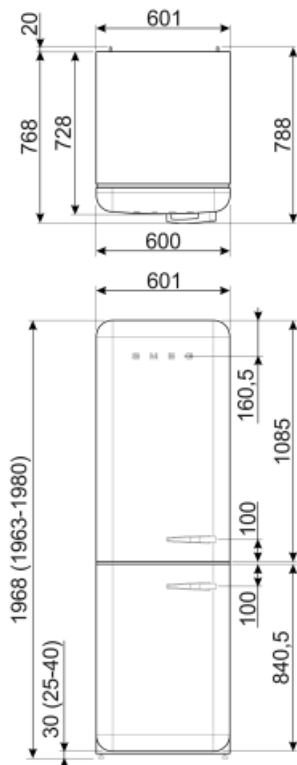

## Alternative products



**FAB32LWH5UK**

**Hinge position:** Left  
White



**FAB32RPB5UK**

**Hinge position:** Right  
Pastel Blue



**FAB32RPG5UK**

**Hinge position:** Right  
Pastel Green



**FAB32RWH5UK**

**Hinge position:** Right  
White



**FAB32RCR5UK**

**Hinge position:** Right  
Cream



**FAB32LPB5UK**

**Hinge position:** Left  
Pastel Blue



**FAB32LRD5UK**

**Hinge position:** Left  
Red



**FAB32LCR5UK**

**Hinge position:** Left  
Cream



**FAB32LPG5UK**

**Hinge position:** Left  
Pastel Green



**FAB32RRD5UK**













**Hinge position:** Right  
Red



**FAB32RBL5UK**

**Hinge position:** Right  
Black

## Symbols glossary

-  4 stars freezing compartment for better food preservation.
-  The automatic defrost system works by automatically defrosting at regular intervals eliminating the need to defrost altogether.
-  Economical mode: Analyzes fridge functioning during the activation and optimizes the operating cycle in order to reduce power consumption.
-  Fast freezing: The fast freezing function brings the temperature of the compartment down when activated a few hours prior to usage.
-  LED interior lighting: is a more energy efficient and long lasting way of illuminating the interior of the appliance.
-  Inverter technology: The evolution of Smeg's driers towards more intelligent and environmentally sustainable models has led to the choice of using Inverter technology with heat pumps, which reduces significantly energy consumption.
-  Energy efficiency class D
-  A+++: Appliances with this symbol can reduce energy consumption by a further 30% from the standard A energy rating.
-  LED display: to show programmes, functions and options selected and the time to the end of the cycle.
-  Ventilated: Forced distribution of cold air in the refrigerator compartment, which allows even temperature distribution within the fridge.
-  Power saving mode: The power saving mode allows you to disable the refrigerator and keep the freezer working.
-  Life Plus 0°C: The temperature in the Lifeplus compartments is kept at 0°C, which preserves fresh meat and fish longer.
-  Air plus: keeps food fresher for longer.