

iQ300, Electric hob, 80 cm, Black, ET81RBHA1D

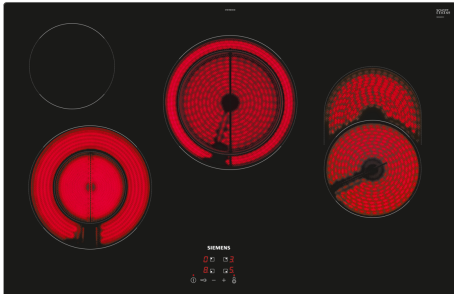

HZ32WA00	Wireless food thermometer
HZ392800	Intermediate bottom
HZ9FE280	Iron pan Ø 18 / 28 cm
HZ9SE030	Set of 2 pots and 1 pan

The modern glass ceramic cooktop for more cooking pleasure and less cleaning effort.

- ✓ Space for large pots and roasting pans thanks to the 21 cm and 23 cm two-ring cooking zones and extendable roasting zone.
- ✓ Space for large roasting pans thanks to the extendable roasting zone.
- ✓ touchControl makes the control of your cooktop especially convenient, just by the touch of a finger.
- ✓ The child safety lock safely prevents unintentional switch-on.

Product name/family: Cooking zone ceramic
 Built-in / Free-standing: Built-in
 Source of energy: Electric
 Number of cooking zones: 4
 Min. required niche size for installation (HxWxD):45 x 780-780 x 500-500 mm
 Width of the appliance: 802 mm
 Dimensions: 45x802x522 mm
 Dimensions of the packed product (HxWxD): . 100 x 1130 x 620 mm
 Weight: 11.4 kg
 Gross weight: 12.0 kg
 Residual heat indicator: Separate
 Location of control panel: Front
 Basic surface material: Ceramic
 Color of surface: Black
 EAN code: 4242003899496
 Nominal power: 220-240 V
 Frequency: 50; 60 Hz



iQ300, Electric hob, 80 cm, Black, ET81RBHA1D

Flexibility of cooking zones

- Ring zone roaster: use roasters on the extendable cooking zone.
- Ring zone double: use regular or larger cookware on the extendable cooking zone.
- Cooking zone front left: 120 mm, 210 mm, 0.75 KW
- Cooking zone rear left: 145 mm, 1.2 KW
- Cooking zone middle: 180 mm, 230 mm, 1.5 KW
- Cooking zone front right: 170 mm, 265 mm, 1.8 KW

Usage convenience

- touchControl: control the power with imprinted +/- touch buttons.
- 17 power levels: precisely adapt the heat with 17 power levels (9 main levels and 8 intermediate levels).

Time saving & efficiency

- reStart function: in case of unintentional switch-off, this feature restores all previous settings by switching on the hob again within 4 seconds.
- quickStop: quickly switch off a cooking zone with one longer touch.

Design

- frameless design
- 80 cm: space for 4 pots or pans.

Safety

- 2 stage residual heat indicators: indicates which cooking zones are still hot or warm.
- Control panel lock: prevent unintended activation of the hob.
- Main on/off switch: switch off all cooking zones at the touch of a button.
- Power on indicator: indicates if the hob is heating.
- Automatic safety switch off: for safety reasons, heating stops after a preset time if not used.

Installation

- Dimensions of the product (HxWxD mm): 45 x 802 x 522
- Min. worktop thickness: 16 mm
- Connected load: 7.4 KW

iQ300, Electric hob, 80 cm, Black, ET81RBHA1D

measurements in mm

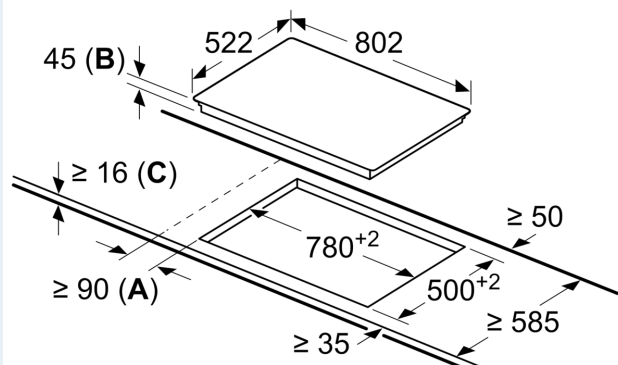

A: Minimum distance from the hob cut-out to the wall.

B: Recessed depth

C: With fitted oven underneath min. 20, possibly more; see space requirements for the oven.