

CX91IMBL

| | |
|----------------------------------|-------------------|
| Cooker size | 90x60 cm |
| N. of cavities with energy label | 1 |
| Cavity heat source | ELECTRICITY |
| Hob type | Induction |
| Type of main oven | Thermo-ventilated |
| Cleaning system main oven | Vapor Clean |
| EAN code | 8017709343194 |
| Energy efficiency class | A |



Aesthetics



| | | | |
|------------------------------------|----------------------|------------------------------|-------------------------|
| Aesthetic | Classica | Type of control knobs | Smeg Classic |
| Series | Concerto | Controls colour | Stainless steel |
| Design | Standard | No. of controls | 2 |
| Colour | Black | Serigraphy colour | Silver |
| Finishing | Black | Display name | DigiScreen |
| Command panel finish | Enamelled metal | Door | Full glass |
| Logo | Embossed | Glass type | Black |
| Logo position | Facia below the oven | Handle | Smeg Classic |
| Hob colour | Black enamel | Handle Colour | Brushed stainless steel |
| Type of control setting hob | Digi Touch | Feet color | Black |
| Hob LED colours | Red | | |

Programs / Functions main oven

No. of cooking functions 8

Traditional cooking functions



Static



Fan assisted



Circulaire



Eco



Small grill



Large grill



Fan grill (large)



Fan assisted base

Cleaning functions

Catalytic

Hob options



| | | | |
|--------------------------------|-----|-----------------------|--------------------|
| Control lock | Yes | Limited Power | 3000, 4500, 7400 W |
| Limited Power Consumption Mode | Yes | Consumption Mode in W | |

Hob technical features



Total no. of cook zones 4

Front left - Induction - single - 2.30 kW - Booster 3.00 kW - Ø 21.0 cm

Rear left - Induction - single - 1.30 kW - Booster 1.40 kW - Ø 18.0 cm

Rear right - Induction - giant - 2.30 kW - Booster 3.00 kW - Ø 21.0 cm

Front right - Induction - single - 1.30 kW - Booster 1.40 kW - Ø 18.0 cm

| | | | |
|------------------------------------|-----|---------------------------------|-----|
| No. of cooking zones with Booster | 4 | Minimum pan diameter indication | Yes |
| Automatic switch off when overheat | Yes | Selected zone indicator | Yes |
| Automatic pan detection | Yes | | |

Main Oven Technical Features



| | | | |
|------------------------------|-------------------|--|--------------------|
| No. of lights | 2 | Removable inner door | Yes |
| Fan number | 2 | Total no. of door glasses | 2 |
| Net volume of the cavity | 115 l | No. of thermo-reflective door glasses | 1 |
| Gross volume, 1st cavity | 129 l | Safety Thermostat | Yes |
| Cavity material | Ever Clean enamel | Cooling system | Tangential |
| No. of shelves | 5 | Usable cavity space dimensions (HxWxD) | 371x724x418 mm |
| Type of shelves | Metal racks | Temperature control | Electro-mechanical |
| Light type | Halogen | Lower heating element power | 1700 W |
| Light Power | 40 W | Upper heating element - Power | 1200 W |
| Cooking time setting | Start and Stop | Grill element | 1700 W |
| Light when oven door is open | Yes | Large grill - Power | 2900 W |
| Door opening | Flap down | Circular heating element - Power | 2 x 1550 W |
| Removable door | Yes | Grill type | Electric |
| Full glass inner door | Yes | | |

Options Main Oven

| | | | |
|-------|-----|---------------------|-------|
| Timer | Yes | Minimum Temperature | 50 °C |
|-------|-----|---------------------|-------|

End of cooking acoustic alarm Yes

Maximum temperature 260 °C

Accessories included for Main Oven & Hob

Rack with back and side stop 1

20mm deep tray

1

Electrical Connection

Plug Not present

Electric cable

Installed, Single phase

Electrical connection rating 10600 W

Additional connection modalities

Double and Three Phase

Current

46 A

Frequency

50/60 Hz

Voltage

220-240 V

Terminal block

5 poles

Voltage 2 (V)

380-415 V

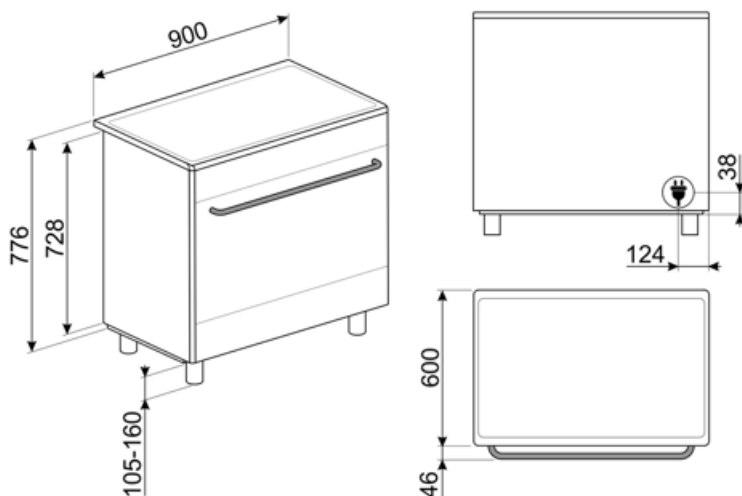

Not included accessories

AIRFRY9

Air fryer rack AIRFRY . Ideal for recreating traditional frying in the oven, but with fewer calories and less fat. It allows you to cook quickly and simply dishes such as French fries, fried vegetables and fish, ensuring perfect browning and crispiness.



SFLK1

Child lock



PRTX

Refractory pizza stone with handles. D=35cm Not suitable for microwave ovens. Suitable for gas ovens, to be put on the griddle.



KIT600SNL-9

Cover strip for hob back side, depth 60mm, suitable for 90cm single oven Concerto cookers



KIT90X9-1

Splashback, stainless steel, 90cm, for Concerto cookers with single MF or gas oven

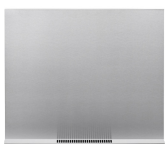

KITPDQ

Height reduction feet (850mm), stainless steel, for Concerto cookers (850-881mm)



PALPZ

Pizza shovel with folding handle. Dimensions L31.5 x H32.5 cm. Easy and convenient to use and store. Perfect for serving pizza, bread and savory pastries in a safe and professional way.



AL90X9

Upstand suitable for 90cm Concert cookers with gas hob and MF oven



GTP

Partially extractable telescopic guides (1 level), suitable for traditional ovens. Made in stainless steel, they guarantee stability and facilitate the smooth extraction of the trays.



PPR9

Refractory pizza stone without handles. Squared shaped stone: L64xH2,3xP37,5 cm Suitable also for gas ovens, to be put on the griddle.



BBQ9



KITH95

Height extension feet (950mm), stainless steel, suitable for Concerto cookers (911-966mm)



SCRP

Non-scratch hob scraper - suitable for induction and ceramic hobs



GTT

Totally extractable telescopic guides (1 level), suitable for traditional ovens. Made in stainless steel, they guarantee stability and facilitate the smooth extraction of the trays.



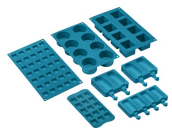





























SMOLD

Set of 7 silicone moulds for ice creams, ice lollies, pralines, ice cubes or to portion food. Usable from -60°C to +230°C

Symbols glossary (TT)

| | |
|--|--|
|  <p>Power booster: option allows the zone to work at full power when very intense cooking is necessary.</p> |  <p>Child lock: some models are fitted with a device to lock the programme/cycle so it cannot be accidentally changed.</p> |
|  |  <p>Installation in column: Installation in column</p> |
|  <p>Air cooling system: to ensure a safe surface temperatures.</p> |  <p>Double glazed doors: Number of glazed doors.</p> |
|  <p>ECO-logic: option allows you to restrict the power limit of the appliance real energy saving.</p> |  <p>Ever Clean Enamel: Ever Clean enamel is applied electrostatically, corner to corner and edge to edge to prevent cracking or cracks over time. It is a particular pyrolytic enamel, resistant to acids which, in addition to being pleasantly bright, promotes greater cleaning of the oven walls, thanks to its lower porosity. It is baked at over 850 ° C and slowly polymerized at a scientifically determined rate to ensure uniform depth and strength Ever Clean enamel creates an impeccable finish both on the inside of the oven and on the trays, making the surfaces of the oven incredibly easy to maintain over time as it reduces the adhesion of fat during cooking</p> |
|  <p>Fan assisted base: the mix of fan and lower heating element alone allows to finish cooking foods already cooked on the surface but not internally more quickly. This system is recommended to finish cooking foods that are already well cooked on the surface, but not internally, which therefore require a moderate higher heat. Ideal for any type of food.</p> |  <p>Fan assisted: Intense and homogeneous traditional cooking, also suitable for complex recipes. The fan is active and the heat comes from below and from above at the same time. Ventilated cooking ensures a faster and more homogeneous result, leaving fragrant foods outside and moister inside. Ideal for baked pasta, biscuits, roasts and cobblers.</p> |
|  <p>Static: Traditional cooking suitable for the preparation of one dish at a time. The fan is not active and the heat comes from below and from above at the same time. Static cooking is slower and more delicate, ideal in order to get well cooked and dry dishes even inside. Ideal for cooking all types of roasts, fatty meats, bread, filled cakes.</p> |  <p>Circulaire: it is the perfect function for cooking all types of dishes in a more delicate way. The heat comes from the back of the oven and is distributed quickly and evenly The fan is active. It is also ideal for cooking on multiple levels without mixing smells and flavors.</p> |
|  <p>ECO: low energy consumption cooking: this function is particularly suitable for cooking on a single shelf with low energy consumption. It is recommended for all types of food except those that can generate a lot of moisture (for example vegetables). To achieve maximum energy savings and reduce time, it is recommended to put the food in the oven without preheating the cooking compartment</p> |  <p>Grill: Very intense heat coming only from above from a double heating element. The fan is not active. Provides excellent grilling and gratinating results. Used at the end of cooking, it gives a uniform browning to dishes.</p> |

-
- | | | | |
|--|---|---|--|
|  | Half grill: For rapid cooking and browning of foods. Best results can be obtained by using the top shelf for small items, the lower shelves for larger ones, such as chops or sausages. For half grill heat is generated only at the centre of the element, so is ideal for smaller quantities. |  | Fan grill: very intense heat coming only from above from a double heating element The fan is active. It allows the optimal grilling of thickest meats. Ideal for large cuts of meat. |
|  | Giant zone: The giant zone offers extra space and flexibility. |  | Overheat protection: The safety system that automatically turns off the hob in case of overheating of the control unit. |
|  | Induction: The work of these hobs is based on the principle of electromagnetic induction. The heat is generated directly in the bottom of the pan during its contact with the hob. |  | All glass inner door: All glass inner door, a single flat surface which is simple to keep clean. |
|  | The inner door glass: can be removed with a few quick movements for cleaning. |  | Side lights: Two opposing side lights increase visibility inside the oven. |
|  | Automatic opening: some models have Automatic opening door when the cycle is finished which is a perfect solution for handle-less kitchen units as no handle is needed. For safety reasons, the door locks automatically when the machine is in use to avoid it being opened inadvertently. |  | The oven cavity has 5 different cooking levels. |
|  | Vapor Clean: a simple cleaning function using steam to loosen deposits in the oven cavity. |  | The capacity indicates the amount of usable space in the oven cavity in litres. |
|  | 4.3 inch display with LED technology, usability with knobs + 3 touch keys |  | Touch control |

Benefit (TT)

True-convection

The best cooking performances guaranteed by ventilated circular flow

Multiple fans and heating elements guarantee the perfect aerodynamic heat flow, allowing homogeneous and quicker cooking inside the cavity.

Catalysis

Easy oven cleaning through the use of catalytic panels in the cavity

This permanent process allows continuous cleaning and degreasing of the three cavity walls, starting its grease oxidation phase when the oven reaches 200°C.

Induction hob

Induction offers fast cooking and precise temperature control

Through the use of suitable cookware, induction is easy to use and maintain, safe and responsive.

Vapor Clean

By inserting water into a recess at the bottom of the cavity, steam is generated, which softens the residue and facilitates its removal

By inserting water into a recess at the bottom of the cavity, steam is generated, which softens the residue and facilitates its removal.

Touch control

Easy and intuitive timer setting with a single touch

Isothermic Cavity

The best cooking performance at the highest energy efficiency

Double Turbine

The oven has two fans equipped with two circular heating elements allowing cooking with rotating heat

Tangential cooling

New cooling system with tangential fan and airflow from the door to the splashback

Multilevel halogen light

Internal halogen lighting on different levels guarantees excellent visibility

Adjustable height

Cooker top flushed with the working area thanks to adjustable feet

Removable inner glass

Internal door glasses are easily removable for complete cleaning

Multilevel cooking

Several cooking levels allow maximum flexibility of use

Cold door

During any function, the external door glass is cold, avoiding any risk of burns

AirFry (AIRFRY optional accessory)

Lighter and tastier food thanks to airfry basket (optional accessory)

BBQ (optional accessory)

Barbeque cooking directly in the oven with the double-sided grill (BBQ optional accessory)

Pizza stone (optional accessory)

Baking with refractory stone for soft and crispy pizza and yeast products (STONE optional accessory)